

THD Comparison Of Modified SHE-PSO PWM With LS-PWM, PS-PWM, POD-PWM, APOD-PWM, NLC-PWM Techniques For 17 Level Inverter With Reduced Switch Count

¹V. Ramu,²Dr. P. Satish Kumar,³Dr. G.N. Srinivas

^{1,3}Department of Electrical and Electronics Engineering, Jawaharlal Nehru Technological University
Hyderabad, Hyderabad

²Department of Electrical engineering, University College of Engineering, Osmania University,
Hyderabad

Abstract:

This paper focusing on the comparison of total harmonics distortion (THD) of the output voltage is minimized by the help of a cascade multilevel inverter with reduced number of switches with un-equal DC sources using the conventional PWM techniques and modified SHE PWM using particle swarm optimization (PSO) algorithm. To address the issues of the multilevel inverters with better performance and efficiency there has been increased advancements with level shift PWM technique, phase shift PWM, POD PWM, APOD PWM and NLC PWM. The paper deals with the analysis of some such advancements like particle swarm optimization techniques and is contrasted to pulse width modulation technique in terms of total harmonic reduction, feasibility, switching pattern of PWM techniques and efficiency. Due to the conventional PWM techniques the complexity of the increased number of elements and harmonics can be reduced with the particle swarm optimization technique and can also determine the optimized switching angles in reducing the selected harmonics. The simulations of the analysis are carried out in the Matlab and the same are presented in the paper which are indeed proved to be better for PSO in contrast to conventional PWM techniques.

Key words: multi-level inverters (MLI), LS-PWM, PS-PWM, POD-PWM, APOD-PWM, NLC-PWM, particle swarm optimization, optimized switching angles, selective harmonic elimination.

1. Introduction:

In modern electrical and electronics the major drawback of the switches is generating the harmonics classified as voltage and current harmonics causing huge loss to the power system. In recent trends of advancements in multi-level inverters has been a wide area for development of new techniques in selective harmonic elimination, increased performance and efficiency. One such area is redefining the switching angles of the multi-level inverter for efficient performance. The ability of the multi-level inverters is to convert high voltages of AC from cascaded DC sources[1,2] thus making the MLI a part of the modern power grids in high power applications due to added benefits of reduced voltage stresses, filter sizes, various methods for operating of switching angles optimization[3-6] and different methods for harmonic elimination.

For elimination of harmonics from the switches of MLI a few techniques like sine triangle PWM[7], Optimal Minimization of Total Harmonic Distortion[8] and Selective Harmonic Disposal Pulse Width Modulation[9] are carried out for symphonious end in the cascaded inverters. Modified SHE-PWM is a popular strategy for exchanging switching angles. This limits the THD from a voltage waveform generated by a voltage-source inverter[10]. Most typically, the Newton-Raphson(NR)

technique is utilized which additionally takes care of the symphonious issue. SPWM strategy is extremely successful for noticing the inverter yield voltage however this technique can make high loss in switching actions.

Optimal minimization THD technique can just cycle to limit the THD, it can't consider the significance of lower and higher frequencies [11,12]. MODIFIED SHE-PWM is the best strategy to wipe out lower harmonics and exposed to low switching losses. It further develops power quality of output and also decreases the expense of channel[13]. The different techniques as NRmethod[14], Walsh functions[15] and Block-pulse [16] functions are engaged with the harmonic minimization process in MLI. These multiple of techniques of harmonic suppression have their own weakness. NR strategy requires initial speculations, disparity issues and gives no ideal arrangement. Walsh function and also Block-pulse strategy just settles direct conditions, on account of non-linear conditions which are troublesome to observe better results of switching.

Thus we need strategy to appropriate initial qualities to merge to a legitimate arrangement. As of late, non-conventional strategies dependent on transformative calculations, like Particle Swarm Optimization (PSO)[17], Bee Calculations[24] have been utilized for inverter harmonic elimination[18].

The Particle Swarm Optimization(PSO) strategy was planned in 1995 by Edward and Kennedy[14]. These calculations were motivated by social behavior of creatures like birds, tutoring fish. This strategy for advancement is based on the reason that people living in general public have an assessment that is essential for a bunch of convictions that are shared by every conceivable person. Every individual can alter his own perspective based on three variables:

- Information about the climate
- Recorded information or past encounters
- Recorded information or previous encounters of people in your area or neighborhood.

The PSO[19] method is like a hereditary calculation that begins with a arbitrary populace grid. In contrast to hereditary calculations, PSO has no administrators like hybrid and transformation. The lines in the lattice are called particles. These contain the variable qualities. Every molecule continues on the expense surface with a given speed. These particles update their speed and position dependent on best available nearby and global arrangements

Thus in this paper the PSO method with selective harmonic elimination(MODIFIED SHE - PSO)[20] is contrasted with the conventional level shift PWM (LS-PWM), phase shift PWM(PS-PWM), phase opposition disposition PWM (POD-PWM), anti-phase opposition disposition PWM (APOD-PWM) and nearest level control PWM (NLC-PWM) to observe the results for two inverter namely: 17 level MLI and 53 level MLI. The various observations such as harmonics, switching patterns, efficiency, performance issues[25] are studied in further sections. The results and observations of the MODIFIED SHE-PSO of 17level MLI are contrasted with the results of 17 level MLI of LS-PWM, PS-PWM, POD-PWM, APOD-PWM and NLC-PWM

2. COMPARITIVE ANALYSIS

2.1 17 level MLI with LS-PWM, PS-PWM, POD-PWM, APOD-PWM and NLC-PWM:

This 17 level MLI connects 10 switches and 4 dc sources generating 17 levels of voltages without any need fro inductor, capacitor, freewheeling diodes. The structure allows us draw maximum of $8V_{dc}$ and min of $-8V_{dc}$ in 17 levels ($8V_{dc}, 7V_{dc}, 6V_{dc}, 5V_{dc}, 4V_{dc}, 3V_{dc}, 2V_{dc}, V_{dc}, 0, V_{dc}, -V_{dc}, -2V_{dc}, -3V_{dc}, -4V_{dc}, -5V_{dc}, -6V_{dc}, -7V_{dc}$ and $-8V_{dc}$). The magnitude of voltage level in main model is given by:

$$V_{dc,main} = (N_{sm} + 1)V_{dc,sub}$$

The proposed configuration of the 17 level MLI is depicted in fig.1 as shown below which has reduced number of switches free of other supporting elements.

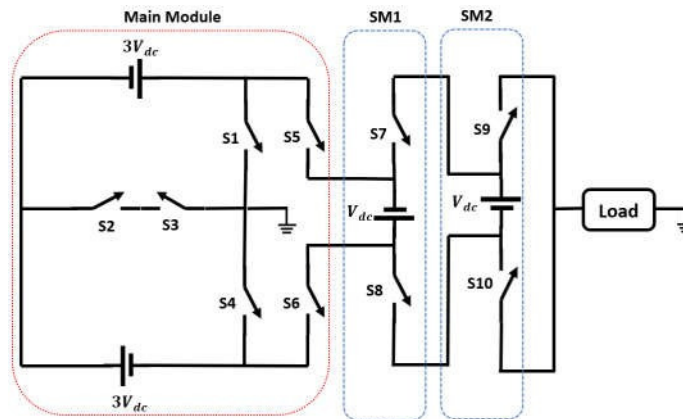

Fig.1 proposed 17 level MLI

The significant power loss of switches in MLIs are due to switching losses and conduction losses[19].Conductionpower losses are more viable in low switching frequencies, though the switching power loss is overwhelming in high frequencies. Conduction loss of IGBT with antiparallel diode is for the on-state condition of resistance and voltages of the two semiconductors and diode. Let V_s is on-state voltage, R_s is the semiconductor resistance, V_d is diode voltage, R_d is resistance of diode. The conduction loss of diode as P_{CD} and semiconductor P_{cs} are: [21]

$$P_{CD}(t) = V_d i(t) + R_d i^2(t)$$

$$P_{CS}(t) = V_s i(t) + [R_s i^\beta(t)] i(t)$$

The proposed low switch count 17 level MLI integrates level shift PWM technique in switching patterns of the MLI to draw the output voltage with reduced harmonics. The output voltage and current patterns of 17 level MLI fare shown in below plots fig. 2. the harmonic profile of voltage and current waves of the 17 level MLI are depicted in fig.3 with modulation index of 1 with LS-PWM technique.

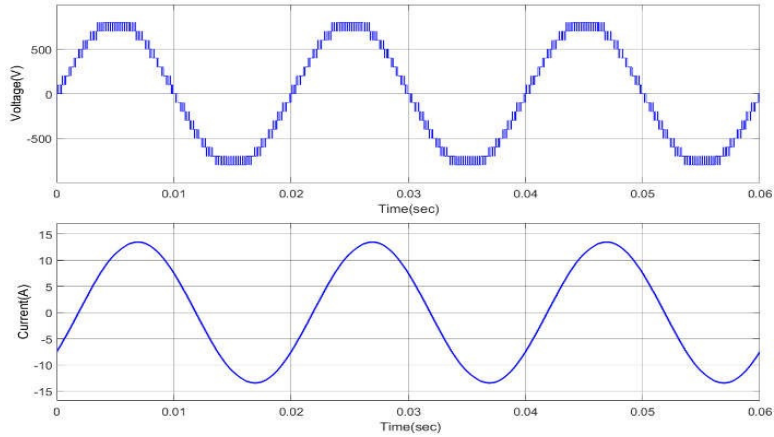

Fig 2. 17 level output voltage and load current with LS-PWM when modulation index is 1 and load is 50Ω and $50mH$

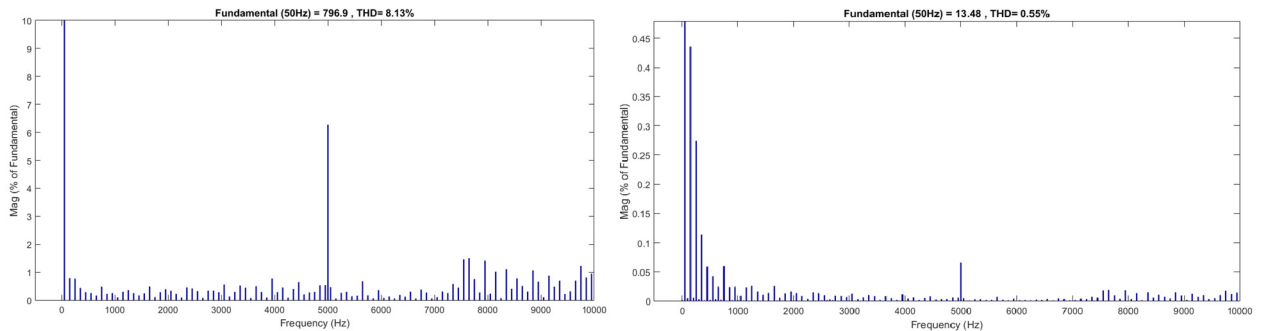

Fig 3. Voltage and current THD with LS-PWM of 17 level inverter with modulation index is 1

The output voltage and current patterns of 17 level MLI are shown in below plots fig. 4. the harmonic profile of voltage and current waves of the 17 level MLI are depicted in fig.5 with modulation index of 1 with PS-PWM technique.

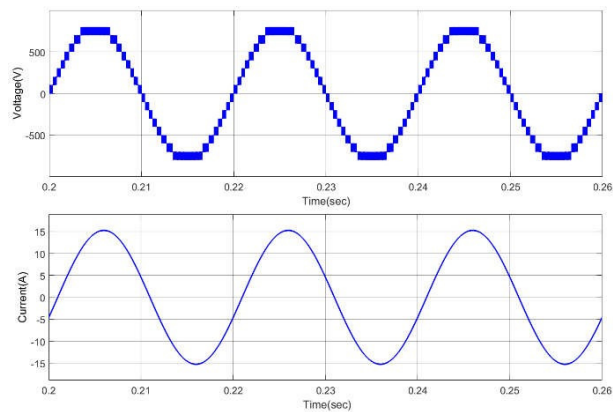

Fig 4. Output voltage and current of 17 level inverter with PS-PWM and modulation index is 1

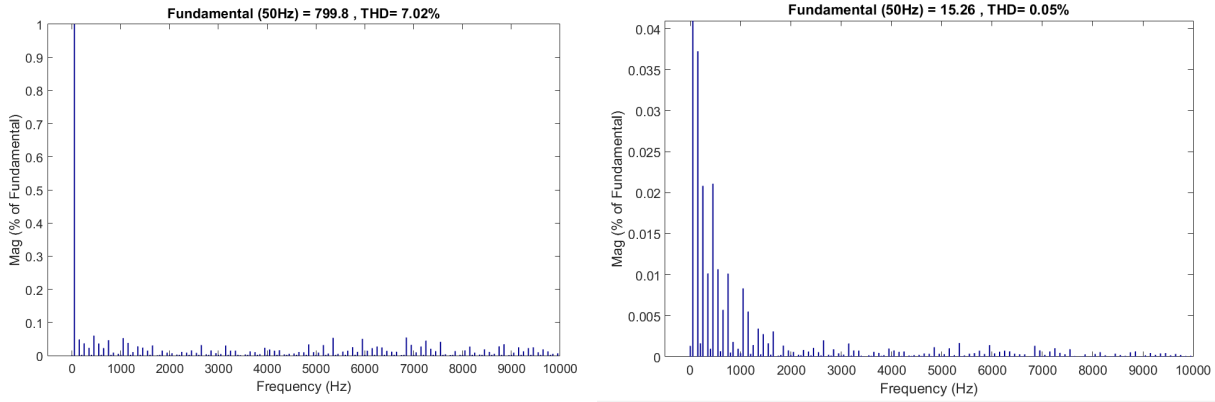

Fig 5. Output voltage and current THD of 17 level inverter with PS-PWM and modulation index is 1

The harmonic profile of voltage and current waves of the 17 level MLI are depicted in fig.6 with modulation index of 1 with POD-PWM technique.

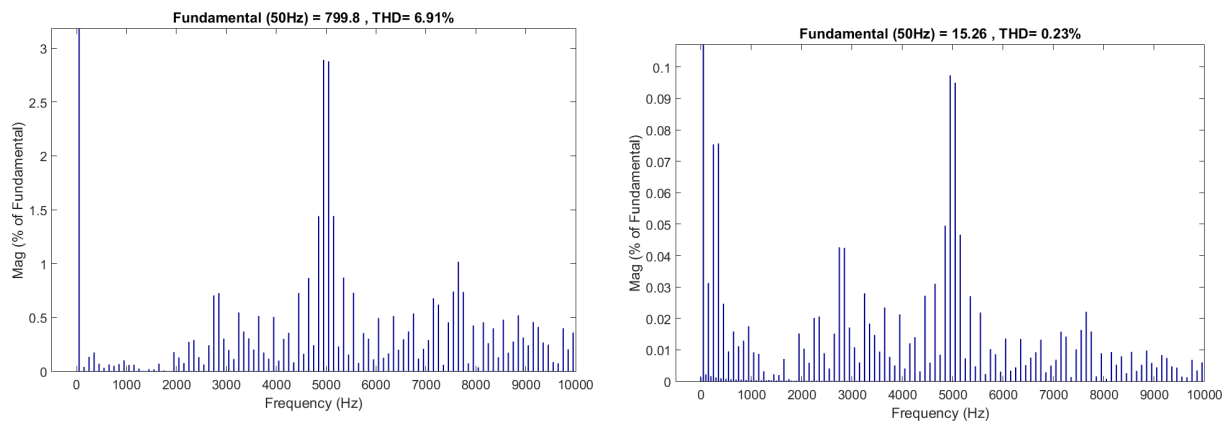

Fig 6. Output voltage and current THD of 17 level inverter with POD-PWM and modulation index is 1

The harmonic profile of voltage and current waves of the 17 level MLI are depicted in fig.7 with modulation index of 1 with APOD-PWM technique.

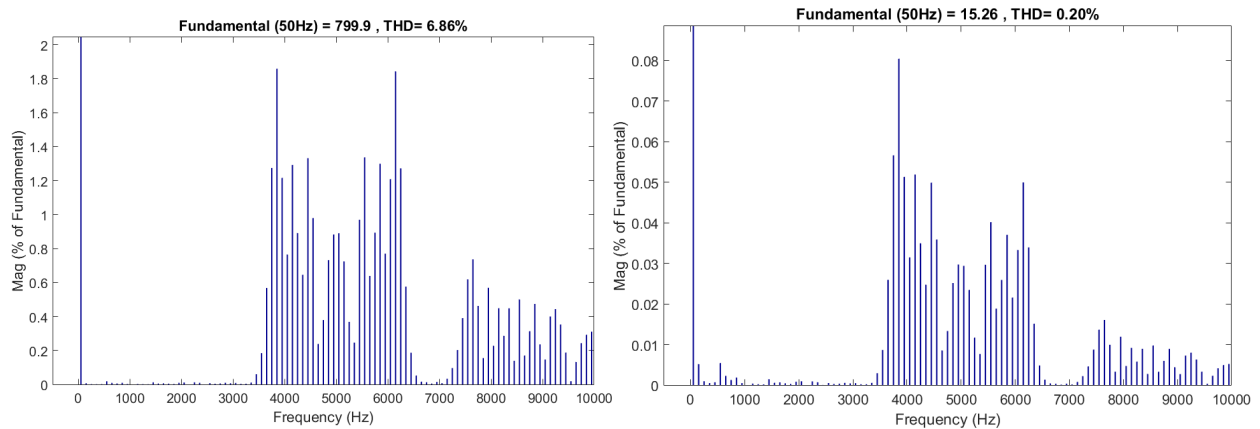

Fig 7. Output voltage and current THD of 17 level inverter with APOD-PWM and modulation index is 1

The output voltage and current patterns of 17 level MLI are shown in below plots fig. 8. the harmonic profile of voltage and current waves of the 17 level MLI are depicted in fig.9 with modulation index of 1 with NLC-PWM technique.

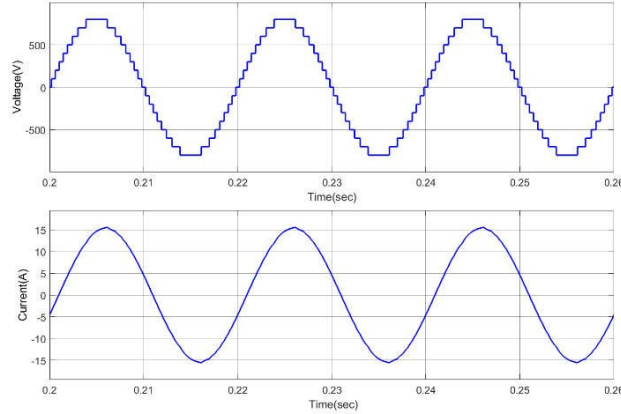

Fig 8. Output voltage and current of 17 level inverter with NLC-PWM and modulation index is 1

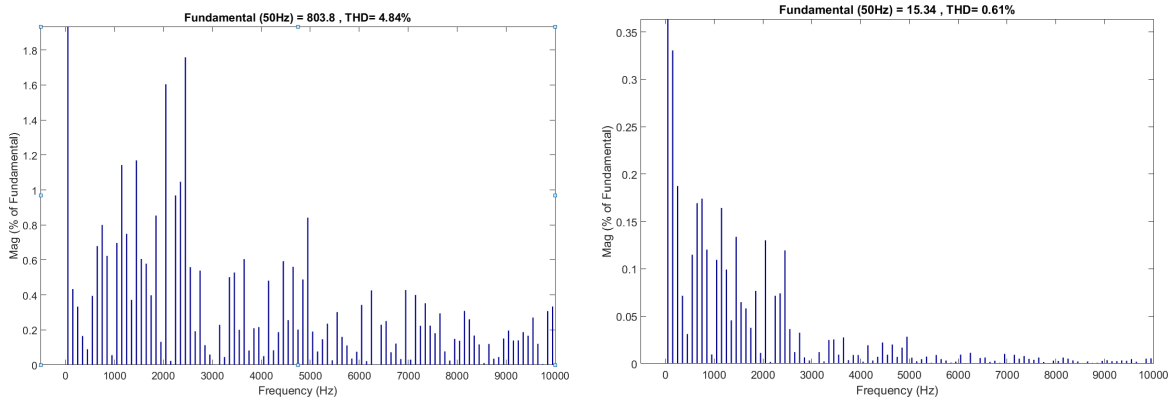

Fig 9. Output voltage and current THD of 17 level inverter with NLC-PWM and modulation index is 1

2.2 Modified SHE-PWM using PSO Algorithm to 17 level inverter

For above proposed 17 level MLI the conduction and switching losses are in calculated in a manner which cannot be suppressed in an easy way. In order to counter the losses and to yield quality output the particle swarm optimization PSO algorithm is utilized for the proposed calculation in 17 level MLI to compute the switching system. Modified SHE PSO is renowned switching procedure that is broadly used to explicitly wipe out the selected order harmonics from the output waveform of the MLI. MLI produces voltage with appropriate switching points. At first glance, harmonics are in the output voltage and moreover, odd frequencies are hard to compute albeit the even harmonics are zero at the resultant output.

Subsequently, modified SHE-PSO technique can utilize Fourier investigation work to compute the odd harmonics in the voltage. Appropriately, Fourier examination of result stage voltage is given by

$$V(\omega t) = \sum_{n=1}^{\infty} V_n \cos(n\omega t) + V_n \sin(n\omega t) \quad (1)$$

The odd harmonics amplitude including the fundamental component of the system can be expressed as

$$a_n = \frac{4V_{cd}}{n\pi} \sum_{k=1}^s \cos(n\theta_k) \quad (2)$$

PSO first described by Kenney and Eberhart in 1995, was inspired by two separate concepts: the idea of swarm intelligence based on the social interaction exhibited by swarm, and the field of evolutionary computation. In PSO algorithm, two best values determine each particle's position. The first one is the best value that the particle achieved so far and has been stored. This value is named as individual best. Another one is obtained by the PSO optimizer among the population so far, which is called global best. Also each particle has a position representing the value of variables and a velocity that directs the particle towards the individual and global bests. The fitness function is a particular type of objective function to find the best solution from among all feasible solutions. In PSO, the constraints can also be included in the fitness function. The PSO algorithm consists of three main steps, as follows:

- Evaluate the fitness of each particle
- Update individual and global best fitness and position
- Update velocity and position of each particle

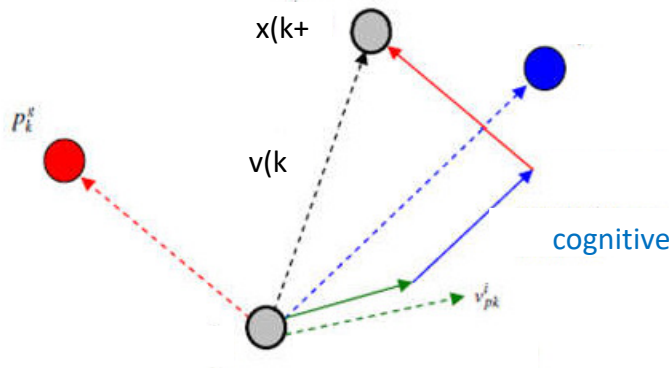

Fig 10. Concept of modification of a searching point by PSO

The position of each particle in the swarm is updated using the equation (3). Where x is particle position and v is particle velocity in the iteration k . The velocity is calculated as follows:

$$v_i(k+1) = \text{Inertia} + \text{cognitive} + \text{social}$$

$$P_{k+1}^i = \omega \times P_k^i + c_1 \times r_{akd1} \times (p_k^i - x_k^i) + c_2 \times r_{akd2} \times (p_k^g - x_k^i) \quad (3)$$

Where, P_i is the best individual particle position and P_g is the best global position, c_1 and c_2 are the cognitive and social parameters, respectively; r_1 and r_2 are random numbers between 0 and 1. c_1 and c_2 are usually close to 2 and affect the size of particle's step towards the individual best and global best, respectively. In this study, both values are assumed to be 2 in order to attract the particle towards the best points equally.

V_{ik} , called inertia, makes the particle move in the same direction and with the same velocity.

If $c1 \gg c2$ then each particle is more attracted to individual best positions, conversely, if $c2 \gg c1$, then the particles are more attracted to the global best positions.

The PSO calculation must be liable for tracking down the ideal switching angles (θ_k) of the arrangement of conditions as depicted in Eq. 2. It limits the THD and helps to maintain the steady & sufficiency of the crucial symphonious part to the ideal output voltage. The calculations were written in MATLAB for both the function fitness and also the PSO. The flow chart for the PSO based algorithm that is implemented for the MLI for 17 level inverter is depicted in fig.11

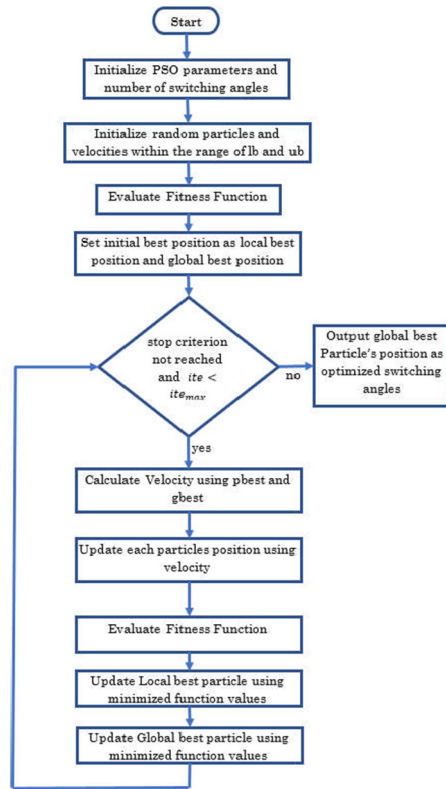

Fig.11 Flow chart of modified SHE-PWM using PSO algorithm in 17 level inverter system.

The output voltage levels of the 17 level MLI after implementing the modified SHE-PSO algorithm into the system is plotted in fig.12. The voltage and current waves obtained after careful analysis and selection of switching angles for optimized performance of MLI are plotted in fig.13.

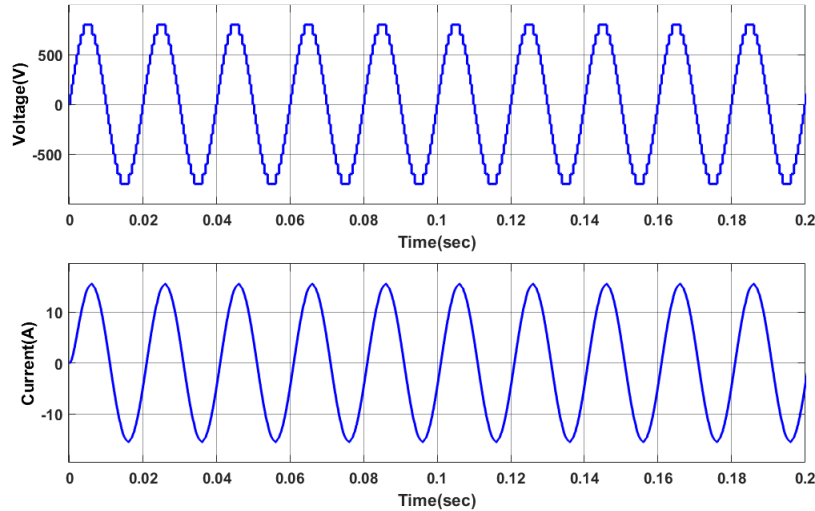

Fig.12 17 level inverter output voltage and current with Modified SHE with 50Ω and 50mH load

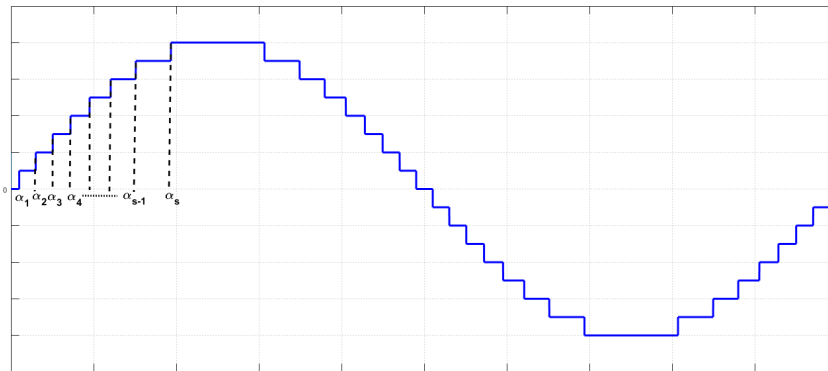

Fig.13 Output voltage levels of MLI with switching angles

The optimized switching angles that are decided by the PSO algorithm after selective elimination of harmonics are tabulated below in table.1 for both the positive and negative waveforms which are:

α_1	3.6
α_2	10.8
α_3	18.18
α_4	25.938
α_5	34.21
α_6	43.4
α_7	54.32
α_8	69.65

Table.1 optimized angles for 17 level inverter with Modified SHE using PSO.

The harmonic analysis of output voltage and current of 17 level inverter with Modified SHE-PWM using PSO is depicted in fig 14. The below results denote the efficiency of the PSO algorithm in terms of voltage and current harmonics, power quality.

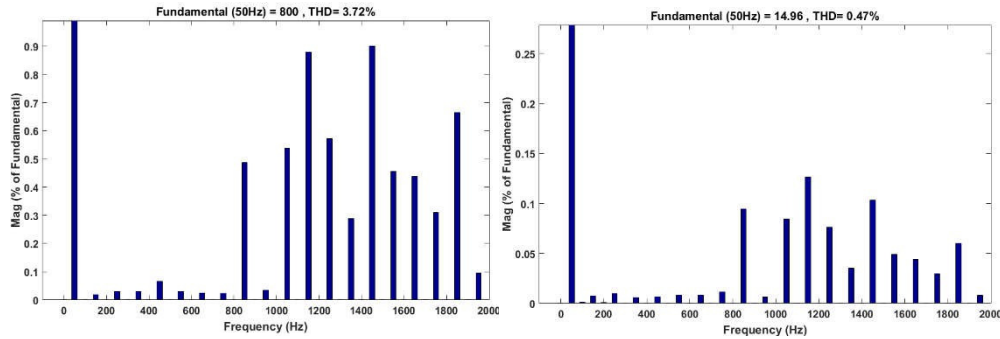

Fig.14THD of output voltage and current for 17 level inverter with Modified SHE using PSO

From the THD analysis it is clear that the harmonic content of the modified SHE-PWM using PSO algorithm is at reduced rate of 3.72% & 0.47% for voltage and current in comparison to conventional PWM techniques like LS-PWM, PS-PWM, POD-PWM, APOD-PWM and NLC-PWM. The comparison of the THD values of all the simulations are tabulated in table.2

Topology	17 level MLI					
PWM technique	LS-PWM	PS-PWM	POD-PWM	APOD-PWM	NLC-PWM	Modified SHE-PWM using PSO Algorithm
Voltage	8.13%	7.02%	6.91%	6.86%	4.84%	3.72%
Current	0.55%	0.05%	0.23%	0.20%	0.01%	0.47%

Table.2 THD comparison of the proposed simulations

III.CONCLUSION

In this paper the modified selective harmonic elimination based PSO algorithm to solve the problem of optimized switching angles and also suppress the higher order harmonics in solving the non-linear transcendental equation. The simulation models and results are provided for both the MLIs for modified SHE-PSO in contrast to LS-PWM, PS-PWM, POD-PWM, APOD-PWM and NLC-PWM techniques. The results from both the simulations prove that the PSO based MLI generates qualitative power with precisely determined solutions, with very lower harmonics in comparison to conventional PWM techniques for 17 level MLI. The output waves denote that the switching angles are optimized with high-speed convergence in the system. The concept of adopting PSO to modified SHE-PWM can be applied to higher levels of multilevel inverters for better improvement in the total harmonic distortion.

REFERENCES

- [1] J. P. Baharu, "Harmonic Reduction of Cascaded H-Bridge Multilevel Inverter Based on Newton-Raphson," vol. 10, no. 3, pp. 6569–6580, 2015.
- [2] M. RaModifiedSHEed, R. Omar, A. Sabari, and M. Sulaiman, "Validation of a Three-Phase Cascaded Multilevel Inverter based on Newton Raphson (N. R.)," vol. 9, no. May 2016, pp. 1–13
- [3]. I. Batsis, D. Bargiotas and A. Daskalopulu, "Switching angles calculation through Mathematical optimization in Multilevel Inverters," 2020 11th International Conference on Information, Intelligence, Systems and Applications (IISA, 2020, pp. 1-4, doi: 10.1109/IISA50023.2020.9284391.
- [4]. Nageswara Rao, Jalakanuru and MeseretYenesewKiber, "Switching Angle Calculation By EP HEP HH And FF Methods for Modified 11-Level Cascade H-Bridge Multilevel Inverter", *International Journal of Engineering Science Invention ISSN (Online)*, vol. 6, no. 12, pp. 69-75, December 2017.
- [5]. N. V. Kumar, V. K. Chinnaiyan, Pradish M. and M. Divekar, "Enhanced power quality of MLI using PSO based selective harmonic elimination," 2015 International Conference on Green Computing and Internet of Things (ICGCIoT), 2015, pp. 42-47, doi: 10.1109/ICGCIoT.2015.7380425.
- [6]. A. Kavousi, B. Vahidi, R. Salehi, M. Bakhshizadeh and N. Farokhnia, "Application of the Bee Algorithm for Selective Harmonic Elimination Strategy in Multilevel Inverters", *IEEE Transactions on Power Electronics*, vol. 27, no. 4, pp. 1689-1696, 2012.
- [7]. Agelidis, V.G., Balouktsis, A., Balouktsis, I., Cossar, C.. Multiple sets of solutions for harmonic elimination pwm bipolar waveforms: Analysis and experimental verification. *IEEE Transactions on Power Electronics* 2006;21(2):415–421.
- [8]. Maswood, A., Wei, S., Rahman, M.. A flexible way to generate pwm-Modified SHE switching patterns using genetic algorithm. In: *Applied Power Electronics Conference and Exposition, 2001. APEC 2001. Sixteenth Annual IEEE*; vol. 2. IEEE; 2001, p. 1130–1134.
- [9]. Sayyah, A., Aflaki, M., Rezazade, A.. Optimization of thd and suppressing certain order harmonics in pwm inverters using genetic algorithms. In: *Computer Aided Control System Design, 2006 IEEE International Conference on Control Applications, 2006 IEEE International Symposium on Intelligent Control, 2006 IEEE*. IEEE; 2006, p. 874–879.
- [10]. Sundareswaran, K., Jayant, K., Shanavas, T.. Inverter harmonic elimination through a colony of continuously exploring ants. *IEEE Transactions on Industrial Electronics* 2007;54(5):2558–2565.
- [11]. Kavousi, A., Vahidi, B., Salehi, R., Bakhshizadeh, M.K., Farokhnia, N., Fathi, S.H.. Application of the bee algorithm for selective harmonic elimination strategy in multilevel inverters. *IEEE Transactions on power electronics* 2012;27(4):1689–1696.
- [12]. Kennedy, J.. Particle swarm optimization. In: *Encyclopedia of machine learning*. Springer; 2011, p. 760–766.
- [13]. Azab, M.. Global maximum power point tracking for partially shaded pv arrays using particle swarm optimisation. *International Journal of Renewable Energy Technology* 2009;1(2):211–235.

- [14]. Hereford, J., Siebold, M.. Multi-robot search using a physically-embedded particle swarm optimization. *International Journal of Computational Intelligence Research* 2008;4(2):197–209.
- [15]. Clerc, M., Kennedy, J.. The particle swarm-explosion, stability, and convergence in a multidimensional complex space. *IEEE transactions on Evolutionary Computation* 2002;6(1):58–73.
- [16]. Ramani, K., Krishnan, A.. An estimation of multilevel inverter fed induction motor drive. *International Journal of Reviews in Computing* 2009;1(1):19–24.
- [17]. Kumar, N., Baskaran, J.. Energy management system for hybrid res with hybrid cascaded multilevel inverter. *International Journal of Electrical and Computer Engineering* 2014;4(1):24.
- [18]. R. M. Hossam, G. M. HaModifiedSHEm and M. I. Marei, "Optimized harmonic elimination for cascaded multilevel inverter," 2013 48th International Universities' Power Engineering Conference (UPEC), 2013, pp. 1-6, doi: 10.1109/UPEC.2013.6714984.
- [19]. J. Kennedy and R. Eberhart, "Particle swarm optimization," in *Proc. IEEE Int. Conf. Neural Netw.*, vol. 4. Perth, WA, Australia, 1995, pp. 1942–1948
- [20]. E. S. Durak, H. I. Okumus, M. A. Usta and H. Kahveci, "Selective Harmonic Elimination with Particle Swarm Optimization in Multilevel Inverters," 2018 IEEE 18th International Power Electronics and Motion Control Conference (PEMC), 2018, pp. 1019-1024, doi: 10.1109/EPEPEMC.2018.8521959.
- [21]. H. S. Patel and R. G. Hoft, "Generalized techniques of harmonic elimination and voltage control in thyristor inverters: Part II - Voltage control techniques", *IEEE Trans. Ind. Applicat.*, vol. IA-10, no. 5, pp. 666-673, Sept./Oct. 1974.
- [22]. H. S. Patel and R. G. Hoft, "Generalized techniques of harmonic elimination and voltage control in thyristor inverters: Part I - Harmonic elimination", *IEEE Trans. Ind. Applicat.*, vol. IA-9, no. 3, pp. 310-317, May/June 1973
- [23]. J. N. Chiasson, L. M. Tolbert, K. J. McKenzie and Z. Du, "Elimination of harmonics in a multilevel converter using the theory of symmetric polynomials and resultants", *IEEE Trans. Contr. Syst. Technol.*, vol. 13, no. 2, pp. 216-223, Mar. 2005.
- [24]. A. Kavousi, B. Vahidi, R. Salehi, M. K. Bakhshizadeh, N. Farokhnia and S. H. Fathi, "Application of the bee algorithm for selective harmonic elimination strategy in multilevel inverters", *IEEE Trans. Power Electron.*, vol. 27, no. 4, pp. 1689-1696, Apr. 2012.
- [25]. A. Amand, and K.P. Singh, "Selective Harmonics Elimination of PWM Cascaded Multilevel Inverter," *International Journal of Engineering Science and Technology (IJEST)*, Vol. 4, No.06, pp. 2743-2747, June 2012.